



GET A SHED THAT WILL LAST YOU A



DURABLE & BUILT TO LAST!

 LOW MAINTENANCE  UV PROTECTED  HEAVY DUTY CONSTRUCTION



LIFETIME SHEDS INNOVATIVE DESIGN

Lifetime sheds combine the quality in design and innovation to offer you a storage solution that will maximise the potential in your day to day use of your garden shed. If you want a shed that will fit the needs of your backyard then choose a Lifetime shed.

For more information please visit our website, or chat to our great team that will help you make the right choice for one of our high quality sheds!



CONTENTS

LIFETIME STORAGE SHED 7x4.5	4
LIFETIME STORAGE SHED 7x7	5
LIFETIME STORAGE SHED 8x5	6
LIFETIME STORAGE SHED 8x7.5	7
LIFETIME STORAGE SHED 8x10	8
LIFETIME STORAGE SHED 10x8	9
LIFETIME STORAGE SHED 11x11	10
LIFETIME HORIZONTAL SHED 3x6	11

OUTDOOR STORAGE SHED

CODE: 60057 | 7 X 4.5



60057

BASE SIZE 2.404(w) x 1.327(d) x 2.279m(h)

DOOR OPENING 1.377 x 1.917m

COLOUR SCHEME

GULL GREY/WINDSOR

With its hinged double doors you can open to nearly 180 degree's giving more clearance when placing items in your shed. Lockable steel-reinforced doors and full length skylight allowing more natural light.

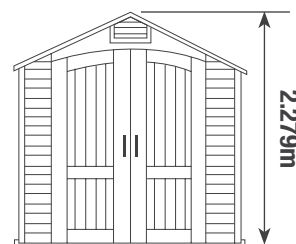

HEIGHT DIAGRAM



- High-density polyethylene plastic and powder-coated steel
- 1 set of double doors with internal spring latch, interior dead bolts, and exterior padlock loop
- Stain-resistant polyethylene plastic flooring, must be supported by a foundation
- 10-year limited warranty

OUTDOOR STORAGE SHED

CODE: 60048 | 7 X 7



60048

BASE SIZE 2.044(w) x 2.044(d) x 2.276m(h)

DOOR OPENING 1.377 x 1.917m

COLOUR SCHEME

GULL GREY/WINDSOR

The larger model of the 60057 has great storage space and even greater features. The UV protected polyethylene plastic protects the shed from weather damage while being low maintenance - no paint required.

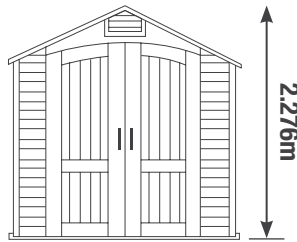

HEIGHT DIAGRAM



- High-density polyethylene plastic and powder-coated steel
- 1 set of double doors with internal spring latch, interior dead bolts, and exterior padlock loop
- Stain-resistant polyethylene plastic flooring, must be supported by a foundation
- 10-year limited warranty



OUTDOOR STORAGE SHED

CODE: 6406 | 8 X 5



6406

BASE SIZE 2.355(w) x 1.409(d) x 2.400m(h)

DOOR OPENING 1.400 x 1.900m

COLOUR SCHEME

GULL GREY/WINDSOR

The 8x5 storage shed is designed to play a big role in a small space. You can keep all your garden equipment right at your fingertips, right where they should be, in your backyard!

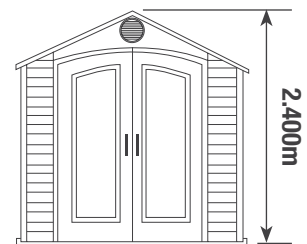

HEIGHT DIAGRAM



- High-density polyethylene plastic and powder-coated steel
- 1 set of double doors with internal spring latch, interior dead bolts, and exterior padlock loop
- Stain-resistant polyethylene plastic flooring, must be supported by a foundation
- 1 latch-n-lock shatter proof windows with polycarbonate panels that slide open for ventilation
- 10-year limited warranty

OUTDOOR STORAGE SHED

CODE: 60015 | 8 X 7.5



60015

BASE SIZE 2.400(w) x 2.200(d) x 2.400m(h)

DOOR OPENING 1.400 x 1.900m

COLOUR SCHEME

GULL GREY/WINDSOR

Now you can store all your outdoor equipment to make your backyard look amazing! And better still having one of our high quality 8 x 7.5 sheds will give your backyard that finishing touch.

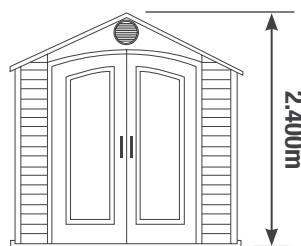

HEIGHT DIAGRAM

- High-density polyethylene plastic and powder-coated steel
- 1 set of double doors with internal spring latch, interior dead bolts, and exterior padlock loop
- Stain-resistant polyethylene plastic flooring, must be supported by a foundation
- 1 latch-n-lock shatter proof windows with polycarbonate panels that slide open for ventilation
- 10-year limited warranty



OUTDOOR STORAGE SHED

CODE: 6405 | 8 X 10



6405

BASE SIZE 2.400(w) x 3.000(d) x 2.400m(h)

DOOR OPENING 1.400 x 1.900m

COLOUR SCHEME

GULL GREY/WINDSOR

The perfect multi-purpose shed to use as your workshop, pool house or general outdoor tool shed. Comes with a shatter resistant double window with open latches which can also be locked.

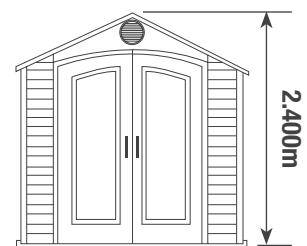

HEIGHT DIAGRAM

- High-density polyethylene plastic and powder-coated steel
- 1 set of double doors with internal spring latch, interior dead bolts, and exterior padlock loop
- Stain-resistant polyethylene plastic flooring, must be supported by a foundation
- 1 latch-n-lock shatter proof windows with polycarbonate panels that slide open for ventilation
- 10-year limited warranty

OUTDOOR STORAGE SHED

CODE: 60118 | 10 X 8



60118

BASE SIZE 3.448(w) x 2.438(d) x 2.438m(h)

DOOR OPENING 1.422 x 1.930m

COLOUR SCHEME

GULL GREY/WINDSOR

The 10 x 8 foot shed is great for all your large outdoor equipment while still making room for your garden tools. With more space this shed is as good as it looks on the outside.



HEIGHT DIAGRAM



- High-density polyethylene plastic and powder-coated steel
- 1 set of double doors with internal spring latch, interior dead bolts, and exterior padlock loop
- Stain-resistant polyethylene plastic flooring, must be supported by a foundation
- 1 latch-n-lock shatter proof windows with polycarbonate panels that slide open for ventilation
- 10-year limited warranty

OUTDOOR STORAGE SHED

CODE: 6433 | 11 X 11



6433

BASE SIZE 3.352(w) x 3.352(d) x 2.844m(h)

DOOR OPENING 2.743 x 1.981m

COLOUR SCHEME

GULL GREY/WINDSOR

Got a ride on mower? Looking for that perfect space to do all your DIY projects? Well this is the perfect shed for you, with a huge 2.743 double door opening you have the luxury to place your larger equipment or work on those projects with plenty of space.

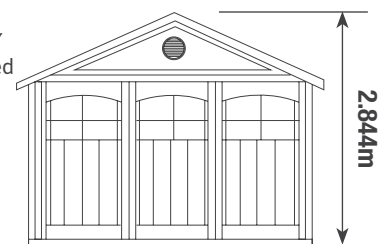

HEIGHT DIAGRAM



- High-density polyethylene plastic and powder-coated steel
- 1 set of double doors with internal spring latch, interior dead bolts, and exterior padlock loop
- Stain-resistant polyethylene plastic flooring ,must be supported by a foundation
- 1 latch-n-lock shatter proof windows with polycarbonate panels that slide open for ventilation
- 10-year limited warranty

HORIZONTAL SHED

CODE: 60088U | 3 X 6



60088U

SIZE 1.911(w) x 1.073(d) x 1.321m(h)

COLOUR SCHEME

GULL GREY/WINDSOR

Need more storage space?

Lifetimes Horizontal shed is great for storing your outdoor bins, wood, or even keep valuable items safe from the elements.

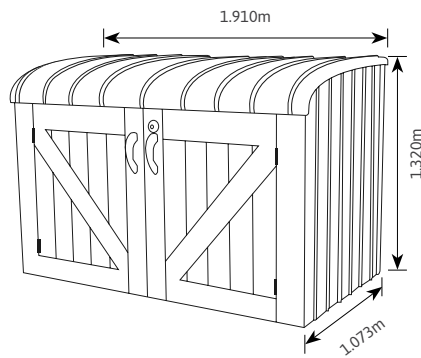

- Double Wall High Density Polyethylene (HDPE) Construction
- Lockable Doors
- Controlled Spring Hinge
- UV protected panels that will not fade, crack or peel
- 5-Year Limited Warranty



Distributed by: Riverlea Group Ltd